

Form: Funktion

Strichstärke

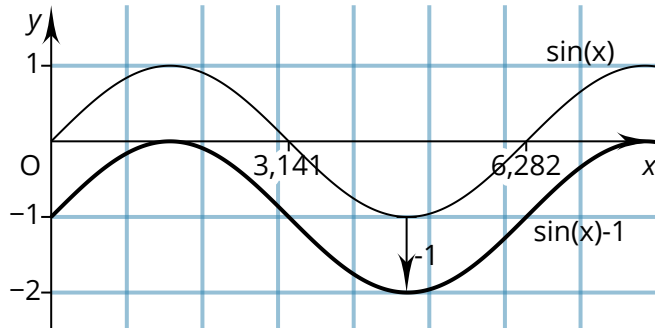

Liniestil

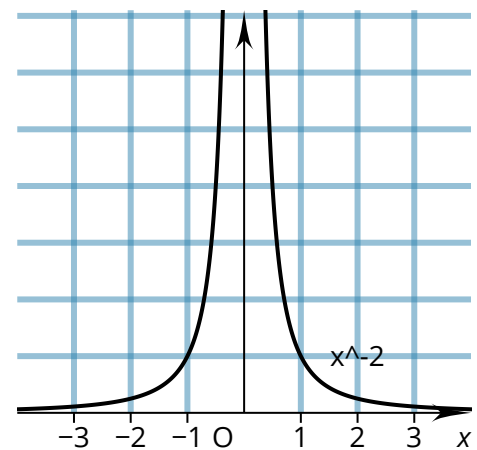
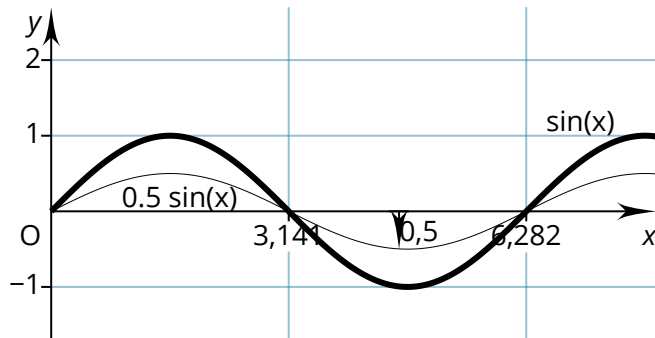
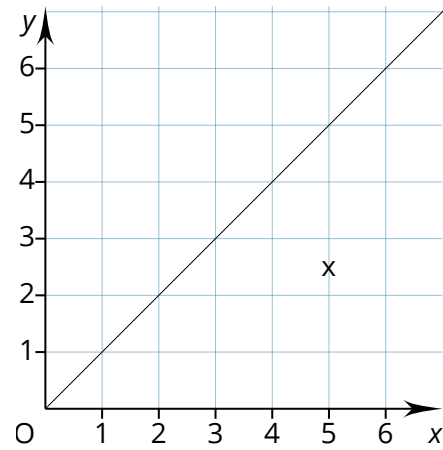
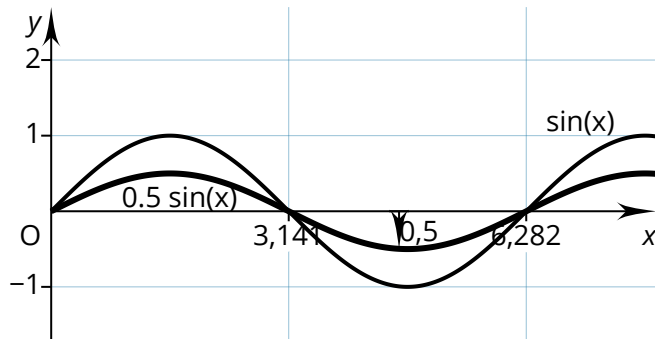
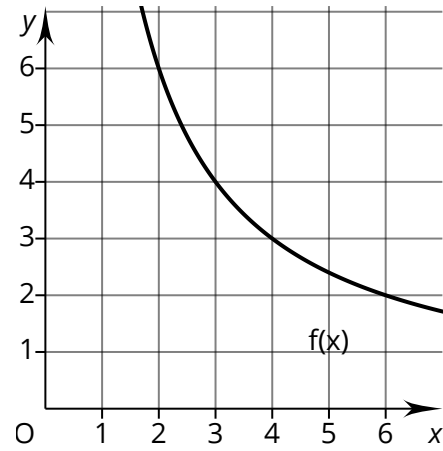
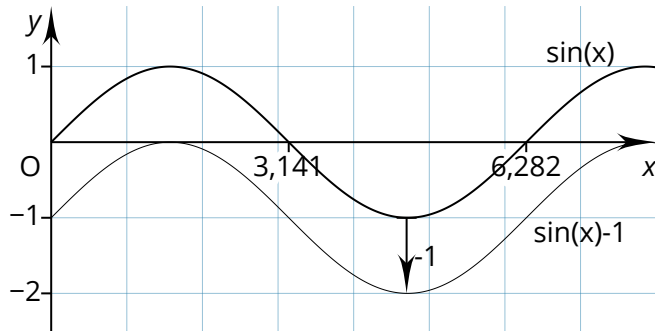
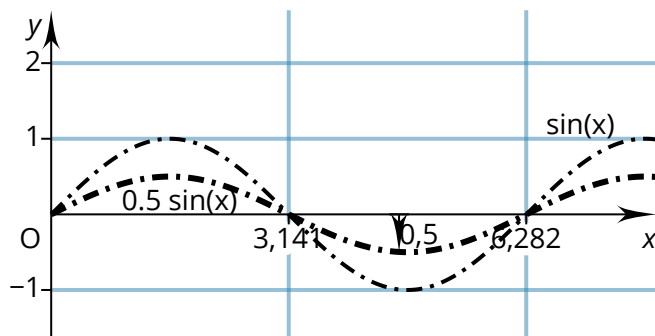
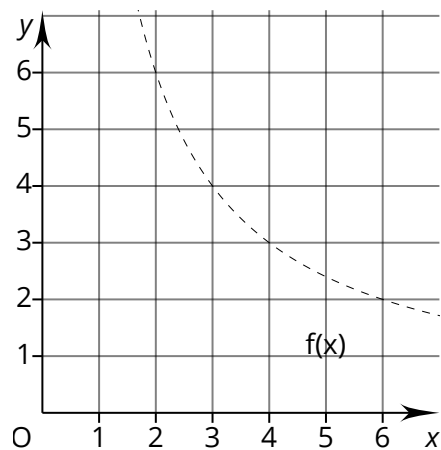
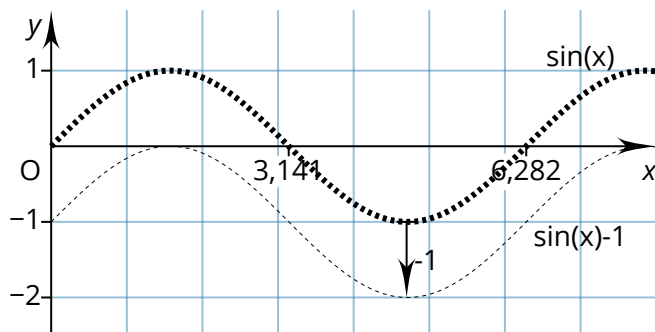
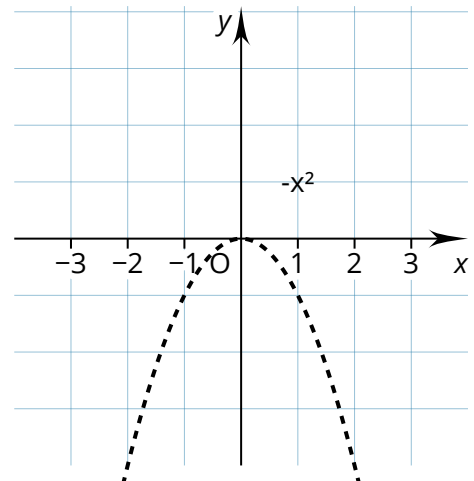
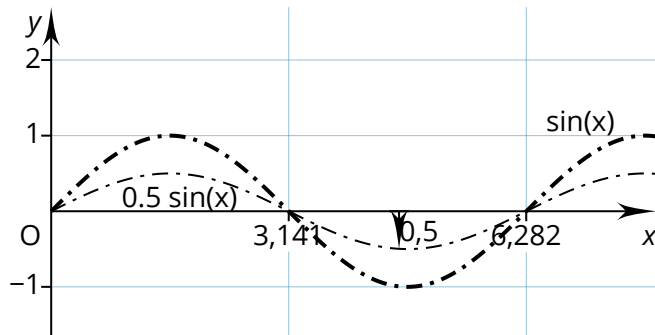
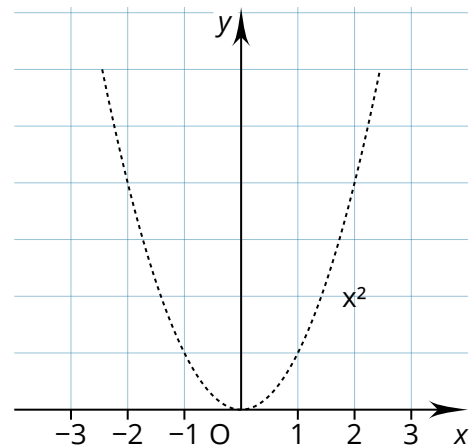
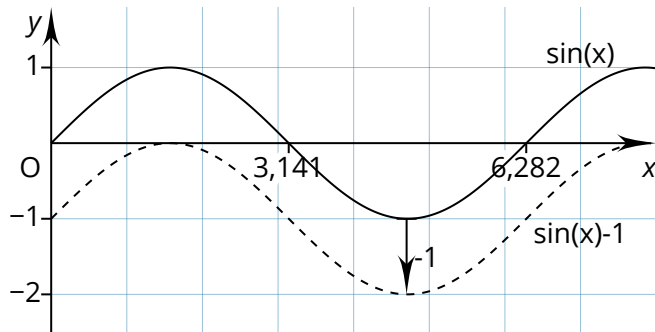

Farbe

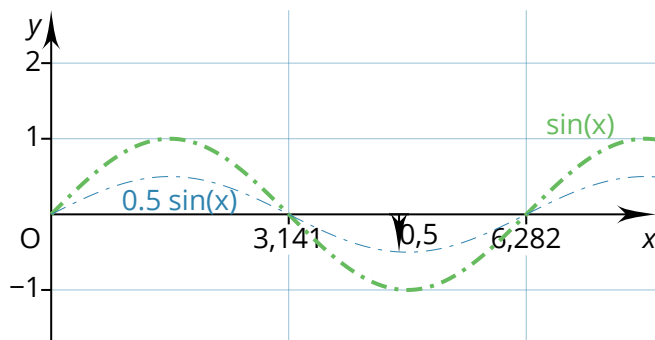
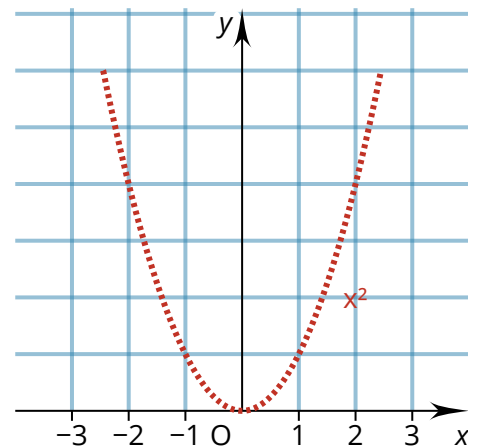
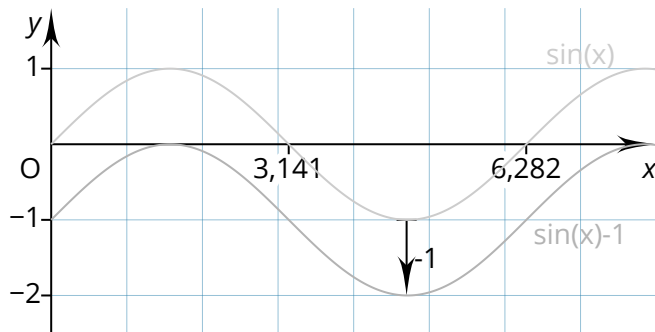
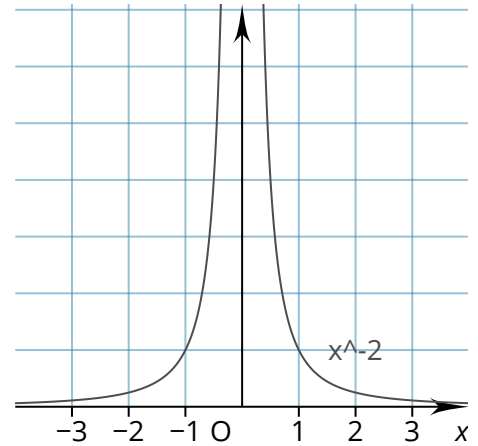
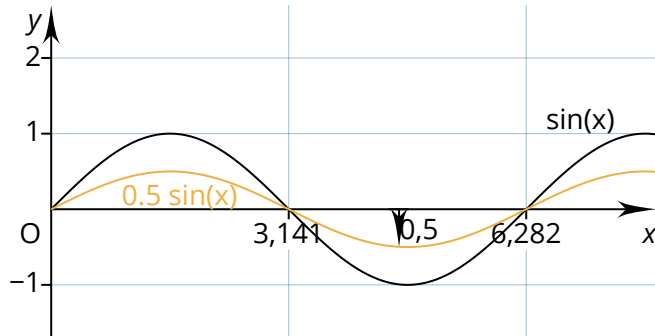
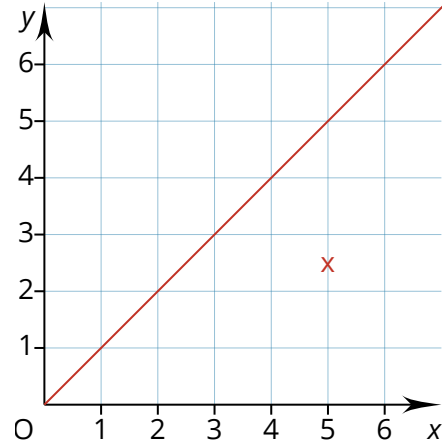
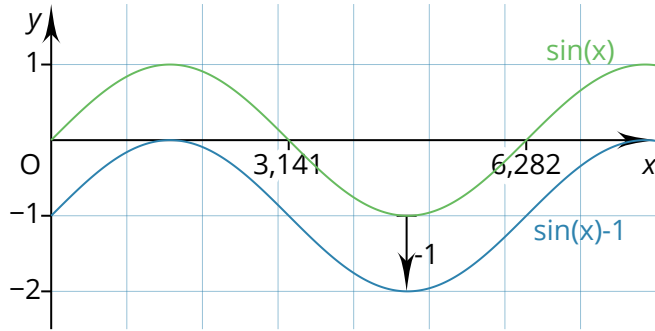

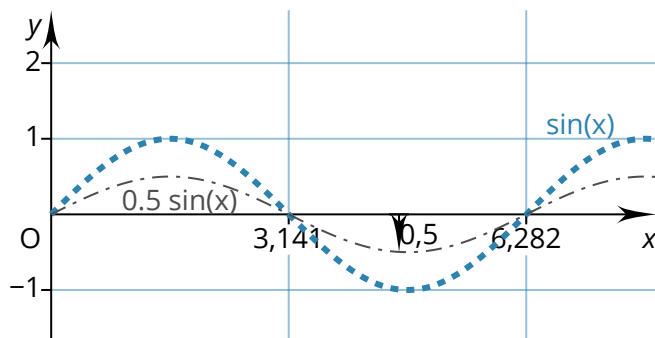
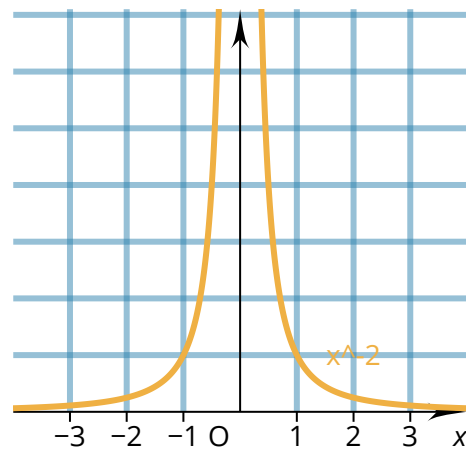
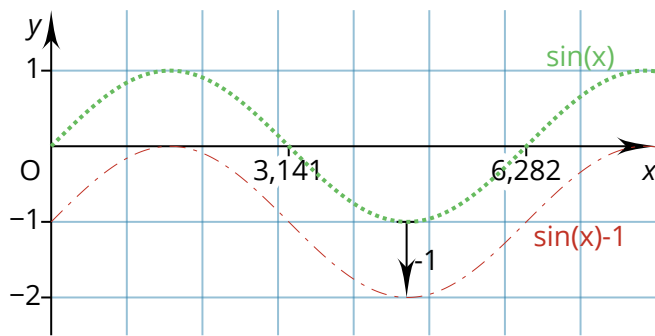
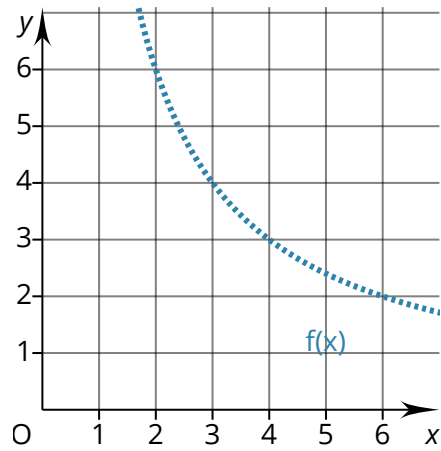
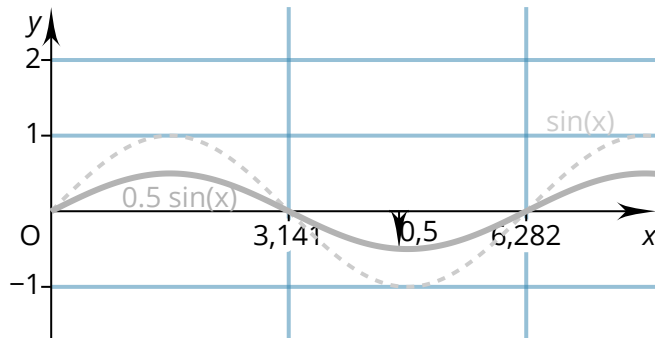
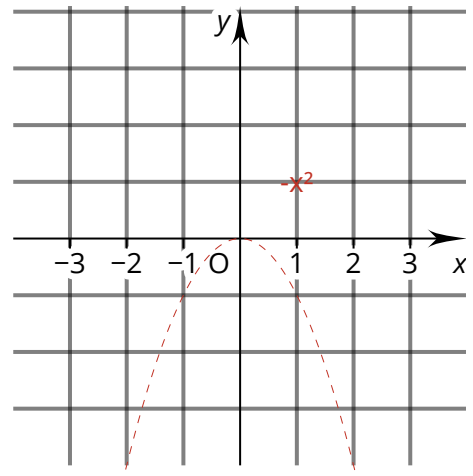
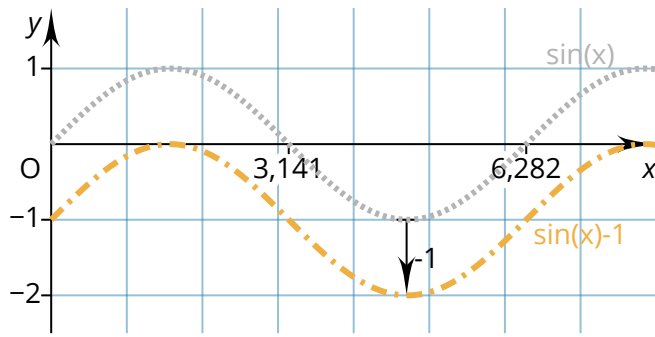

Füllung

